

PQE Series High Energy Solid-state Laser

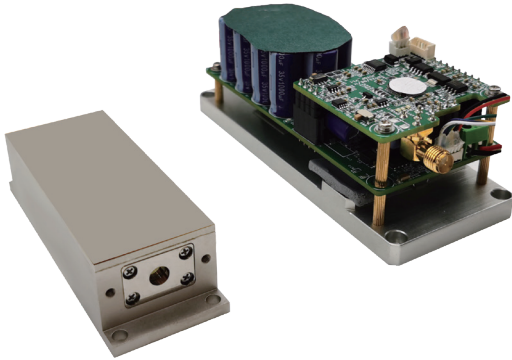

This series of solid-state lasers are RealLight's self-developed, passively Q-switched diode-pumped solid-state lasers, featuring high energy, good value and low power consumption. The integrated design of diode-pumped module and laser crystal results in the compactness. And water cooling is not required for this laser. This series is also available with miniaturized drive boards for OEM control for applications include LIBS and laser ablation, which is easy to install and integrate, and is suitable for handheld devices.

Key Features

- ◆ Pulse width < 3ns
- ◆ Pulse energy >10mJ
- ◆ Compact size, no water cooling required
- ◆ Suitable for handheld devices
- ◆ Cost effective

Applications

- Laser ablation
- Laser-induced breakdown spectroscopy (LIBS)
- Optical damage threshold testing

Technical Specifications

Optical Parameters		
Part Number	PQE-1064-0.01-10	
Wavelength(nm)	1064	
Repetition rate(Hz)	10	
Pulse energy (mJ)	>10	
Pulse width (ns)	<3	
Power stability (RMS)	<3%	
Full angle divergence Typ. (mrad)	Horizontal @1/e ²	3
	Vertical @1/e ²	3
Cooling method	air cooling	
Laser dimensions (W×H×L,mm)	83×30×22.1	
Operation temperature (°C)	10~35	
Storage temperature (°C)	-20~60	
Driver Parameters		
Supply power voltage	12VDC	
Control interface	RS-232,I/O	
Power consumption (W)	15W (MAX)	
Drive board dimensions (W×H×L,mm)	45×39.6×110.3	
Trigger mode	Trigger In/Out	

Order Information

Wavelength (nm)	Part Number	Repetition rate(kHz)	Pulse energy(mJ)
1064	PQE-1064-0.01-10	0.01	10

Part Numbering Schema

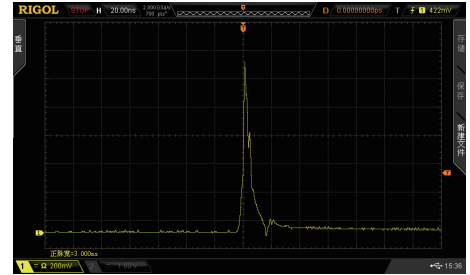
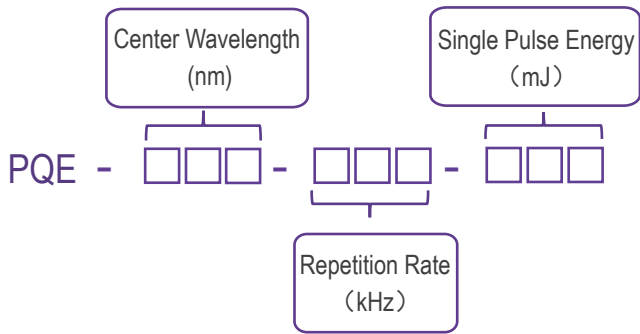

Typical pulse width

Mechanical Drawings (in mm)

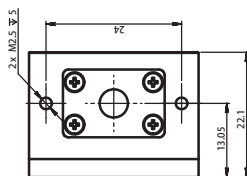
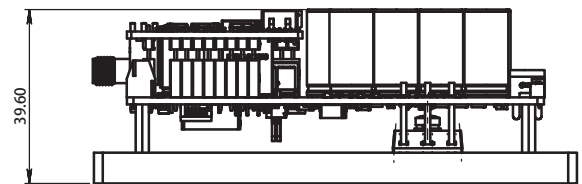
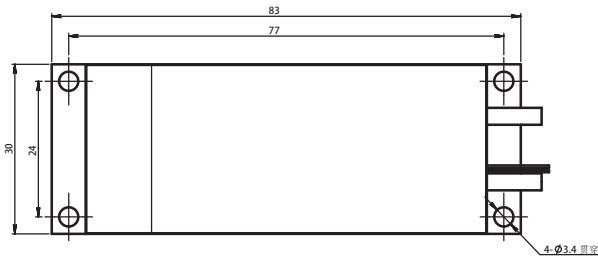

Laser Head

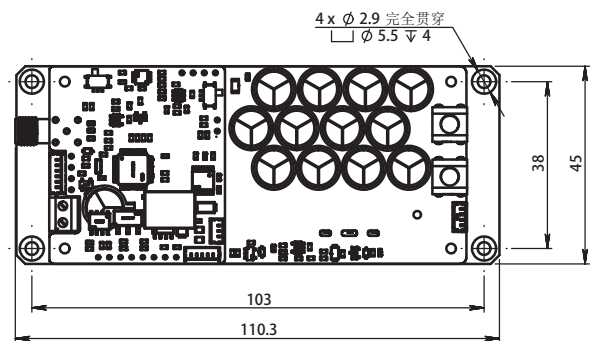

Board

